



# BUILDERS' AND CONTRACTORS' GUIDE FOR ELECTRIC SERVICE CAROLINAS



---

## Toll Free Telephone Numbers

Residential Services	800.454.3853
Commercial Services	800.653.5307

## Utility Locating Company

N.C. 800.632.4949

S.C. 888.721.7877

## Work Request Status Information

We now offer a quick and easy way to:

- Apply for residential temporary and permanent service
- Check on the status of an existing work request
- Schedule a permanent underground service installation (in subdivisions only)

Visit our Website at **duke-energy.com** or call the Builder Line Number. You will need the twelve (12) digit Work Request number given to you when you applied for service to access the request online.

### Site Ready Requirements

- Route Clear (minimum 10' width between power source and meter base, and conduit installed if driveway in route).
- Meter Base Ready
- Grading at final grade
- Builder Underground Obstacles Located
- Septic Systems, Drain Fields and Designated Repair Fields must be marked.

---

## Welcome!

Welcome to the Duke Energy service area. We look forward to working with you to make your business a success.

We've learned over the years that our success depends to a great extent upon yours. That's why we take a partnership approach with all our area builders, developers and customers. Our goal is to provide safe, reliable electric service.

To help us do a better job for you, we need to know your electrical needs as early as possible in the planning stages of your project. This handbook explains what materials and services are provided by Duke Energy. It can also help you understand what guidelines to follow prior to requesting service.

Thank you for choosing Duke Energy. Remember, we're here to assist you in any way we can. If you have service needs other than those listed in this handbook, please contact us by calling the 24-hour Customer Service numbers listed on the opposite page for your particular type of service request – residential or commercial.



## **Table of Contents**

Permits & Inspections .....	2
Temporary Construction Service .....	3
Residential Services: Permanent Overhead .....	7
Site-Built Homes .....	8
Manufactured Homes .....	11
Residential Services: Permanent Underground .....	14
Site-Built Homes .....	15
Manufactured Homes .....	16
Meter Base Ready Policy .....	17
Standard Labeling for Multiple Meter Enclosures .....	19
Commercial Services: Permanent Overhead .....	20
Commercial Services: Permanent Underground .....	22
Changes in Commercial Services .....	24
Outdoor Lighting: Duke Energy .....	25

# How to get temporary residential and commercial service.

## **Don't Forget Your Permits/Inspections!**

Duke Energy cannot connect any electrical service without the proper permit/inspection. A permit and/or inspection is necessary for connecting a temporary service, a permanent service, or an upgraded service. Please contact the proper city or county department to obtain a temporary permit and/or inspection. If an inspection is required, we must be notified that a temporary construction inspection has been granted before we can connect your temporary construction service.

For permanent service, contact your city or county inspector for a final inspection after all service wiring is complete. We are unable to install a meter at your job site and connect your permanent service until the final inspection is done.

If you're unsure about whom to call for inspections in your area, contact us by calling **800.454.3853**.

---

*NOTE: To avoid delay in getting service, please apply for Duke Energy service before the final inspection has been completed.*

---

## **Application for Temporary Service**

Prior to beginning construction, you will need to complete an application for electric service. Your application for temporary service alerts us that you need power at your construction site. It also enables us to set up your account on our building construction rate. Applications are available for both temporary and permanent service online or by fax.

To request an application, call **800.454.3853** or visit **duke-energy.com**.

---

*IMPORTANT NOTICE: The requirements listed on the following pages apply only to electric service of 120/240V, single phase, 200 amps or less except where noted.*

---

## A Standard Temporary Overhead Service Pole With or Without Brace(s)

- Customer Furnishes & Installs
- Duke Furnishes & Installs

**WARNING:**  
Pole or timber structures shall not be attached to trees.

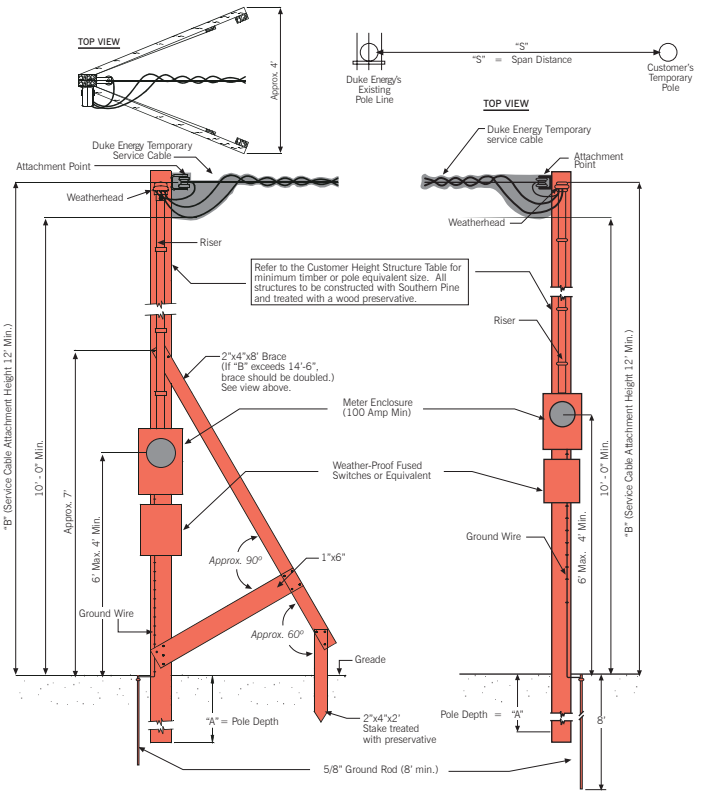

## Temporary Construction Service

Customer Height Structure Table			
Nature of surface under Duke Cable	S	B	
	Span Distance <sup>1</sup>	Minimum Attachment height above ground for Duke's Service cable <sup>1</sup>	Minimum Timber or Pole equivalent size
12' NESC Clearances over Spaces and Ways Subject to <u>Pedestrians Only</u>	0'-30'	12'	4" by 4"
	30'-50'	14'	4" by 6"
	50'-80'	16'	4" by 6"
	80' to 100' max.	16'	6" by 6"
16' Clearance over <u>Roads, Streets, and Other Areas Subject to Truck Traffic</u> for SC	0'-30'	16'	6" by 6"
	30'-50'	18'	6" by 6"
	50'-80'	20'	6" by 6"
	80' to 100' max.	23'	6" by 6"
16' Clearance over <u>Driveways, Parking Lots and Alleys</u> for NC & SC			
18' NESC Clearances for <u>Roads, Streets and Other Areas subject to Truck Traffic</u> for NCDOT requirements	0'-50'	20'	6" by 6"
	50'-80'	23'	6" by 6"

Customer Structure Burial Depth		
Type of Temporary Structure	"A" = Pole Min. Burial Depth <sup>2</sup>	Backfill around Structure
Braced	2'	Well tamped and compacted backfill; average or good soil (firm sand, clay and gravel-type).
Self-Supporting Structure (no braces)	4'	
Braced	3'	Poor soil (soft or wet clay), loose sand, soft clayish silt-type soil
Self-Supporting Structure (no braces)	5'	

### NOTES:

1. Based on Table 232-1 NESC.
2. The span distance is the distance from the customer's temporary pole to the nearest Duke pole line.
3. Add 6" to burial depth when attachment height is 18' or higher.

## A Standard Temporary Underground Service

- Customer Furnishes & Installs
- Duke Furnishes & Installs

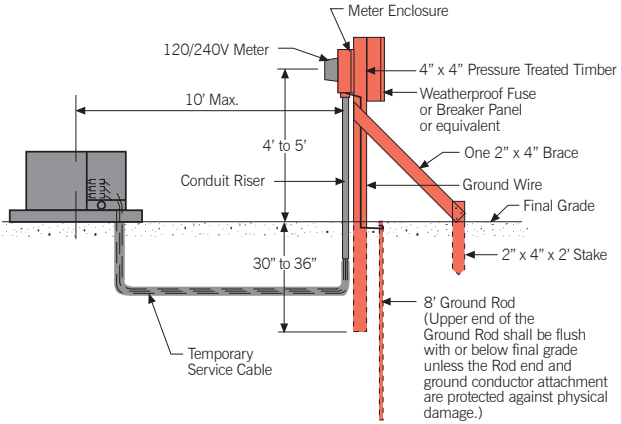

*NOTE: Standard Temporary Construction Service in an underground facility is available within 10 feet of existing power facilities (padmount transformers or underground pedestals).*

## Non-Standard Temporary Service

Charges will be applied to any non-standard temporary service. The definitions for standard temporary services are found above and on the previous pages. Please consult your local Duke Energy engineering department for installation details and charges.

## Site-Built, Manufactured, and Modular Homes Permanent Overhead Service

In order to get your electric service as quickly as possible, you can apply for service at **duke-energy.com** or call **800.454.3853** 24 hours a day, 7 days a week to apply for permanent service. Your application alerts us about your need for power. Please complete this process as early in the planning stage as possible. We will need time to secure any rights of way, plan and build any lines needed, spot your meter location and complete any other work required to install your electrical service. A faxable application is available from your Manufactured Home Retailer.

---

*NOTE: The electric meter on a single family residence should be located on the exterior of the structure on the side closest to Duke Energy's equipment (pole, pad mounted transformer or service radial).*

---

### A Typical Permanent Overhead Residential Service

- Customer Furnishes & Installs
- Duke Furnishes & Customer Installs
- Duke Furnishes & Installs

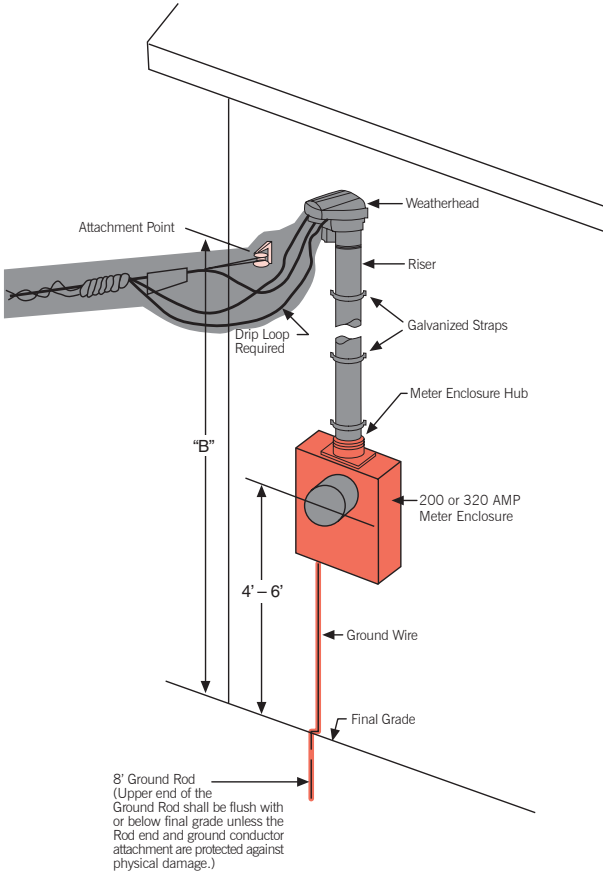

*Residential Services: Permanent Overhead*

---

		"B"
NESC Clearances <sup>1</sup>	Area from the Customer's Home to the Duke Energy Line	Minimum Attachment Height above ground to Duke's Service Cable
12'	Spaces or Ways Subject to Pedestrians Only	14'
16'	Driveways, Parking Lots and Alleys for the states of North Carolina and South Carolina	20'
16'	Roads, Streets and Other Areas Subject to Truck Traffic for State of South Carolina	20'
18'	Roads, Streets and Other Areas Subject to Truck Traffic for the State of North Carolina per DOT Requirements	23'

Note: 1. The 12', 16' and 18' clearances are based on the National Electrical Safety Code (NESC) and DOT.

---

*NOTE: If the attachment point height cannot be obtained from the ground directly above the meter box, then the customer should provide an attachment point by installing a properly secured galvanized steel mast.*

---



## **Manufactured Home Service**

Service to a manufactured home generally follows the same guidelines as permanent residential service to a site-built house. Single-wide manufactured homes normally have the meter enclosure mounted on a service pole. For meter enclosure exceptions, please follow the guidelines as specified in the National Electrical Code (NEC).

---

*IMPORTANT NOTE FOR MANUFACTURED HOMES: Since a manufactured home can be set up on site within 24 hours, you need to notify Duke Energy as soon as a site is chosen. This will give us enough time to coordinate a method of service including primary line work, if necessary, and will enable us to plan accordingly. A faxable application is available from a Manufactured Housing Retailer.*

---

*NOTE: Duke Energy also strongly requests that you **not** position your service pole so that our conductors (primary, secondary or service wire) cross your manufactured home.*

---

## A Typical Permanent Overhead Manufactured Home Service Pole

- Customer Furnishes & Installs
- Duke Furnishes & Installs

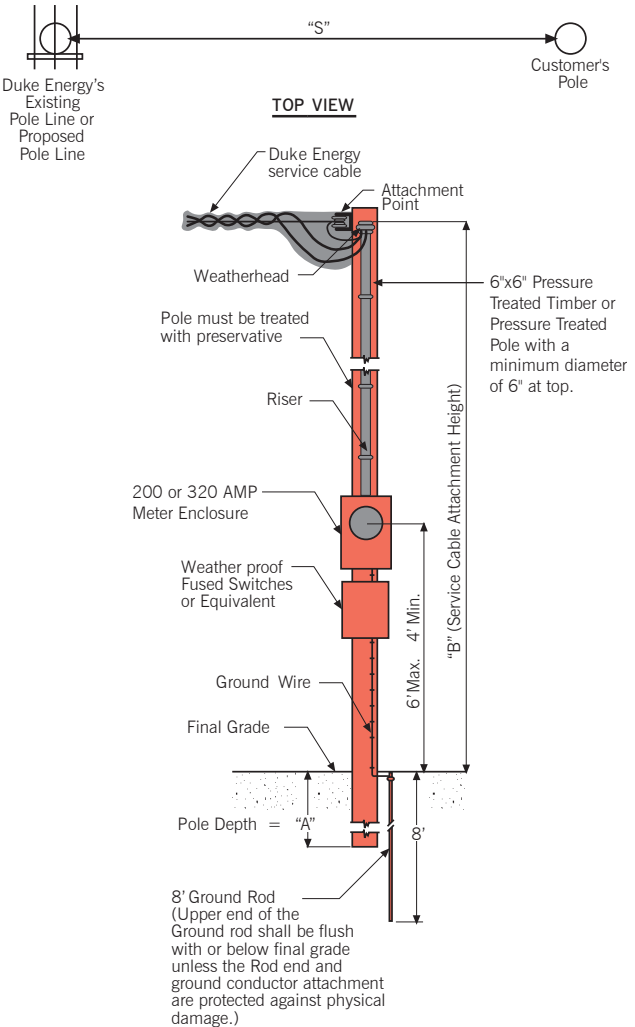

## Residential Services: Permanent Overhead

	"S"	"A"	"A"	"B"
NESC Clearances <sup>2</sup>	Area from the Customer's Pole to the Duke Energy Line	Minimum Burial Depth <sup>1</sup> in Average or Good Soil	Minimum Burial Depth <sup>1</sup> in Poor Soil	Minimum Attachment Height above ground to Duke's Service Cable
12'	Spaces or Ways Subject to Pedestrians Only	4'	5'	14'
16'	Driveways, Parking Lots and Alleys for the states of North Carolina and South Carolina	4' 6"	5' 6"	20'
16'	Roads, Streets and Other Areas Subject to Truck Traffic for State of South Carolina	4' 6"	5' 6"	20'
18'	Roads, Streets and Other Areas Subject to Truck Traffic for the State of North Carolina per DOT Requirements	4' 6"	5' 6"	23'

- Notes:
1. The Minimum Burial Depth is based on well tamped and compacted backfill; Average or Good Soil is firm sand, clay and gravel-type soil. Poor Soil is soft or wet clay, loose sands and soft clayish silt-type soil.
  2. The 12', 16' and 18' clearances and pole heights, size and depth are based on the National Electrical Safety Code (NESC) and DOT.

## **Site-Built, Manufactured and Modular Homes Permanent Underground Service**

To get your electric service as quickly as possible, you can apply for service at **duke-energy.com** or call **800.454.3853** 24 hours a day, 7 days a week to apply for permanent service. Your application alerts us to your need for power. Please complete this process as early in the planning stage as possible. This allows us time to secure any rights of way, plan and build any lines needed, spot your meter location and complete any other work required to install your electrical service.

After reviewing your application, we may contact you to obtain additional information. We will need to determine at this meeting whether Duke's conductor (electrical wire) will lie under any concrete or structure (driveway, deck, patio, etc.). If so, then arrangements will need to be made to avoid any future damage to your property should the cable require repair or replacement.

---

*NOTE: The electric meter on a single family residence should be located on the side closest to Duke Energy's equipment (pole, pad mounted transformer or service radial). A clear route between the power source and the meter enclosure must be maintained to avoid charges. If a driveway is to be placed in this route and needs to be installed before the underground service is installed, you will need to install 3-inch Schedule 40 electrical conduit (with a pull string) with a minimum 24-inch cover from the top of the conduit, making sure both ends of the conduit are clearly marked above ground.*

---

### A Typical Permanent Underground Residential Service

- Customer Furnishes & Installs
- Duke Furnishes & Installs

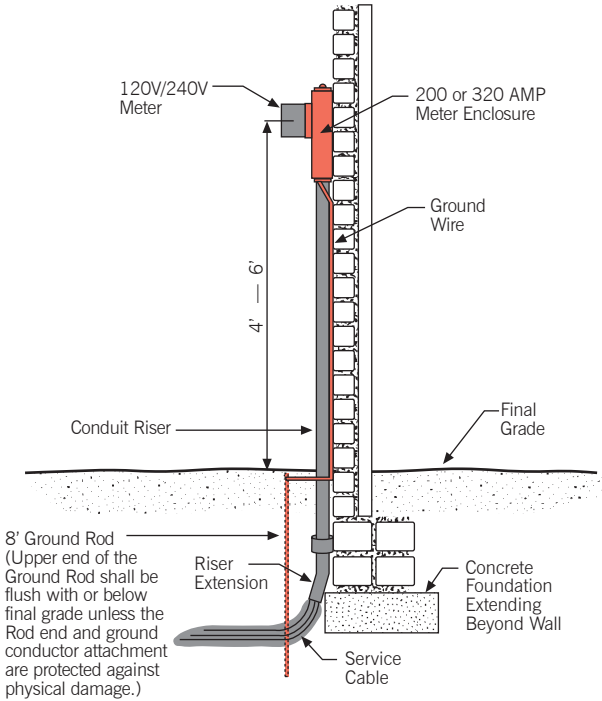

### A Typical Permanent Underground Manufactured Home Service

- Customer Furnishes & Installs
- Duke Furnishes & Installs

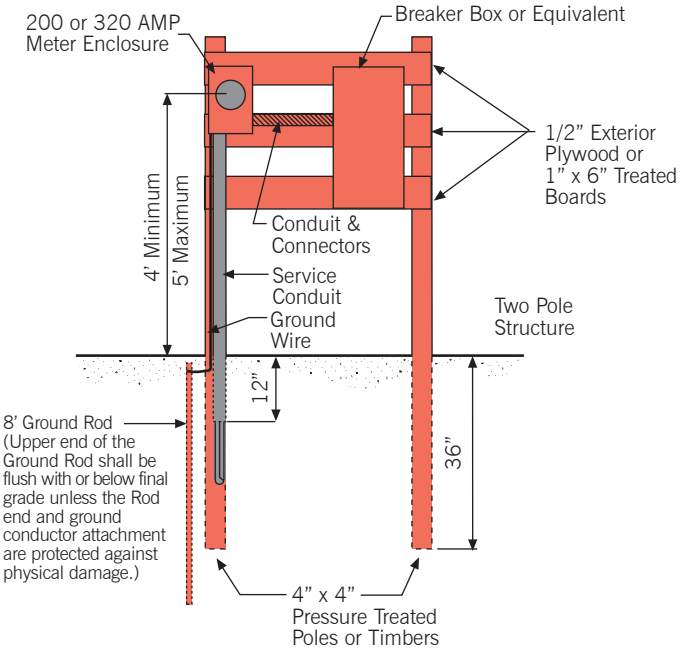

### Meter Base Ready Policy

Duke Energy’s standard practice is to install service cables to permanently installed meter bases, to streamline installation, and to avoid damage to service cables. A permanently installed meter base includes load wires, ground rod, and the grounding conductor. If there are situations that prevent you from doing this, we may mutually establish a “guaranteed” meter base location. However, once the “guaranteed” meter base location is specified and the underground service is installed, you will be responsible for all costs associated with relocating Duke Energy facilities to a new meter base location.

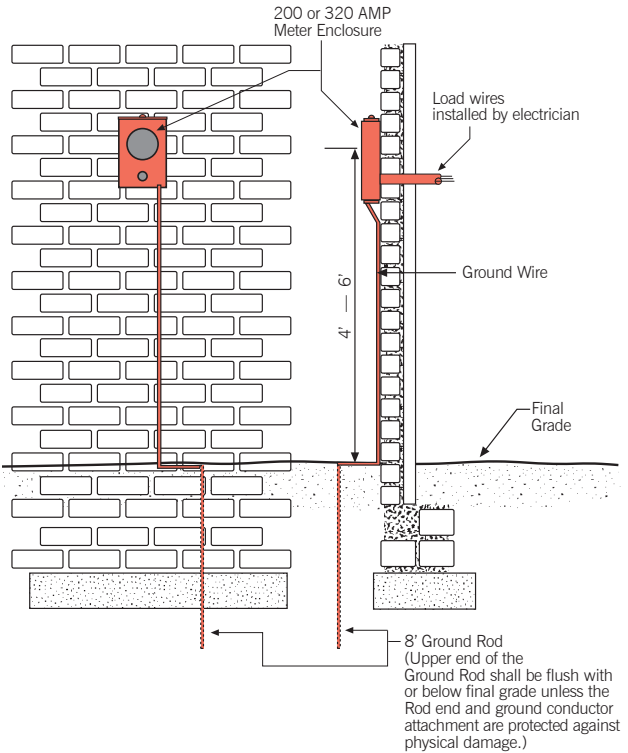



## Standard Labeling of Multiple (Ganged) Meter Enclosures

- Customer Furnishes & Installs
- Duke Furnishes & Installs

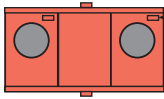

Each meter enclosure shall be correctly identified on the outside front with characters a minimum of 1/2 inch in height of a permanent and legible nature to indicate the apartment number, office suite, lot number, etc. Any attached plate (not required) should be riveted, not bolted and should be attached prior to energizing the socket, and not interfere with the electrical clearances or introduce moisture. In addition, the inside of each meter enclosure shall be correctly identified with a permanent marker.

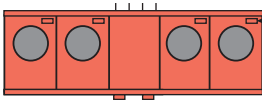

## **Overhead**

To obtain commercial service, you can call Duke Energy at 800.653.5307. A Duke Energy specialist will work with you to obtain the necessary business and electrical load information. If you do not know your electrical load information, we can mail or fax you an electrical load information form and your electrical contractor or other electrical consultant can determine your electrical needs (load, conductor, size, delivery voltage, etc.).

Duke Energy will need time to secure any rights of way, plan and build any lines needed and complete other line work required to install your electrical service.

The following voltages are available to our commercial customers:

120/240 V single phase

208 Y/120 V 3 phase, 4 wire

460 Y/265V 3 phase, 4 wire

480 Y/277 V 3 phase, 4 wire

4,160 Y/2,400 V 3 phase, 4 wire\*

12,470 Y/7,200 V 3 phase, 4 wire\*

24,940 Y/14,400 V 3 phase, 4 wire\*

240 V, 480 V, 575 V, 2300 V, 3 phase, 3 wire

\* Available for overhead service only. All other voltages are available for overhead or underground deliveries.

For commercial service through 200 amperes capacity and 240 volts three phase delta or all other commercial three phase or single phase service through 320 amperes and up to 240 volts, the following requirements need to be met:

## *Commercial Services: Permanent Overhead*

---

### *CUSTOMER FURNISHES AND INSTALLS*

- Riser
- Weatherhead
- Ground Rod and Ground Wire
- Meter Enclosure — Position the meter enclosure so the meter is a minimum of four feet or a maximum of six feet from final grade. Meter enclosure specifications for CT Cabinet or Meter Trough can be obtained from your local Duke Energy engineering department. Access to the meter enclosure should also be free of any obstructions. The meter enclosure is available from your local equipment supplier.
- Final inspection before the meter is installed.

### *DUKE FURNISHES, CUSTOMER INSTALLS*

- Attachment point — Should be located below the weatherhead except where it is impractical to do so because of clearance requirements. The height of the attachment point is dictated by the applicable National Electrical Safety Code. In those cases where it is impractical, the weatherhead must be within 24 inches of the point of attachment.

### *DUKE FURNISHES AND INSTALLS*

- Service cable
- Connectors and connections

---

*NOTE: For commercial service greater than 320 amperes or 200 amperes three wire delta, or greater than 240 volts, specification drawings are available by calling 800.653.5307.*

---

## **Underground**

To obtain commercial service, you can call Duke Energy at 800.653.5307. A Duke Energy specialist will work with you to obtain necessary business and electrical load information. If you do not know your electrical load information, we can mail or fax you an electrical load information form and your electrical contractor or other electrical consultant can determine your electrical needs (load, conductor, size, delivery voltage, etc.).

Duke Energy will need time to secure any rights of way, plan and build any lines needed and complete other line work required to install your electrical service.

You need to identify all existing and proposed underground facilities so they will not be damaged during installation of underground electrical facilities.

For commercial service through 200 amperes capacity and 240 volts three phase delta or all other commercial three phase or single phase service through 320 amperes and up to 240 volts, the following requirements need to be met:

### *CUSTOMER FURNISHES AND INSTALLS*

- Service Pole — If required.
- Ground Rod and Ground Wire
- Meter Enclosure — Position the meter enclosure so the meter is a minimum of four feet or a maximum of six feet from final grade. Meter enclosure specifications for CT Cabinet or Meter Trough can be obtained from your local Duke Energy engineering department. Access to the meter enclosure should be free of any obstructions. The meter enclosure is available from your local equipment supplier. (200A meter enclosure or larger is required.)
- Final inspection before the meter is installed.

## *Commercial Services: Permanent Underground*

---

### *DUKE FURNISHES AND INSTALLS*

- Conduit into Meter Enclosure
  - Underground Service Conductor — From an energy source to the customer's meter box
- 

*NOTE: For commercial service greater than 320 amperes or 200 amperes three wire delta, or greater than 240 volts, specification drawings are available by calling 800.653.5307.*

---

## **For Changes In Your Commercial Permanent Service Overhead or Underground**

Have your electrical service needs changed? Do you have an additional load, or do you need to relocate your electrical facilities?

If the answer is yes, then you need to update your service application information. This can be done by calling 800.653.5307.

Please call us as early in the planning stages as possible. This allows us time to secure any additional rights of way, modify or build any needed lines, and complete any other work required to meet your new electrical needs.

### *REQUIREMENTS*

A request for changes outside of normal working hours may involve a charge. Duke Energy can provide any additional information needed and/or any cost involved in upgrading or changing your service. If you want to change any underground services, please identify all existing and proposed underground facilities. This helps prevent damage to underground facilities during installation or modification of your electrical facilities.

### **Duke Energy Lighting**

Duke Energy offers exterior lighting as a service to our customers. Lighting is available in four major categories: area, street, decorative, and flood lighting.

Exterior lighting enhances the appearance of the property and aids in the security of the home and business. Studies have shown that a well lighted area deters crime.

Our lighting systems provide automatic dusk-to-dawn operation. One low monthly fee covers installation, maintenance, and energy. Our products are available in a variety of styles designed to meet your every need. We can assist in the selection of an option that best fulfills your outdoor lighting requirements.

A growing concern in many communities is how to provide outdoor lighting for safety and security while trying to minimize light trespass (unwanted light shining on your property) and light pollution (spill light illuminating in the night sky). Duke Energy promotes environmentally friendly quality lighting solutions and offers several lighting choices that help communities address these issues.

To order or learn more about how Duke Energy's outdoor lighting service can work for you, please visit us at **[duke-energy.com](http://duke-energy.com)** or call the 24 hour Customer Service number **800.454.3853**.



